

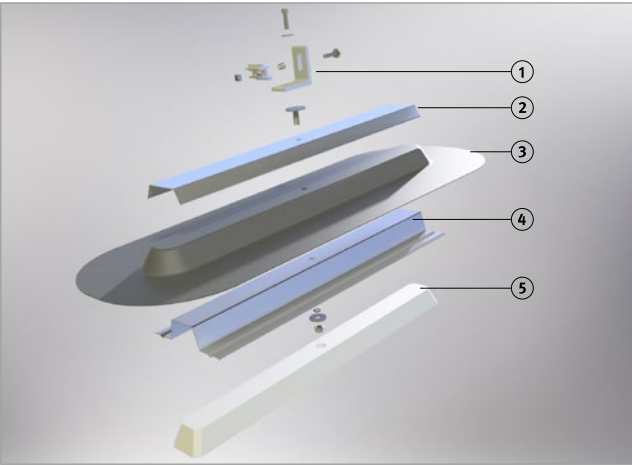

Non-ballasted fastening of solar systems for roofs with EVALON® and EVALASTIC® waterproofing

EVATEC® Solar 450 mounting rail Exploded view

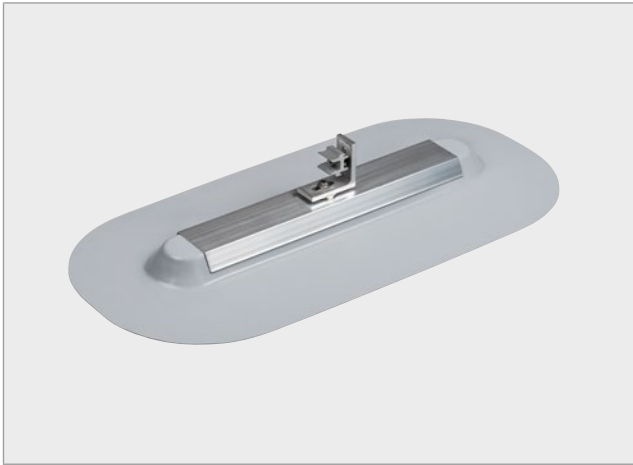

EVATEC® Solar 450 mounting rail with one Rapid system connector
 (Rapid system connector with Schletter clamping block included in delivery)

- ① Rapid system connector
- ② Aluminium cover rail
- ③ Prefabricated part made of EVALASTIC® or EVALON®
- ④ Aluminium support rail
- ⑤ Insulation core

Notes on design and use:
 EVATEC® Solar is a tested building product for the installation of approved constructions on roofs with waterproofing. The use of EVATEC® Solar for fastening photovoltaic systems with approved fasteners requires structural design verification based on established technical building regulations and building authority approvals (see DIBt approval Z-14.4-921).



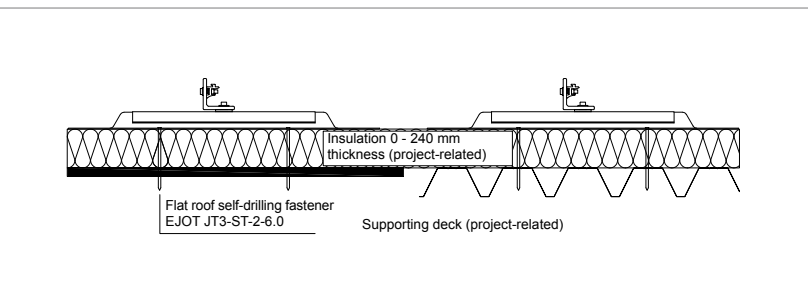
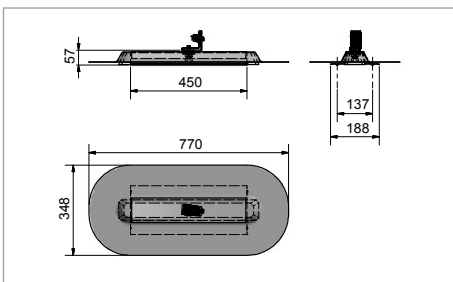



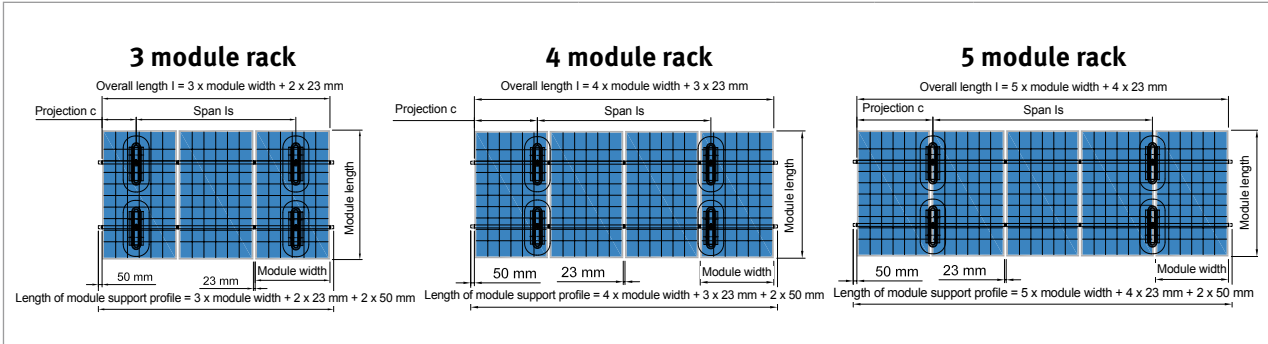



Product details Longitudinal section construction with EVATEC® Solar



Standard assembly (3/4/5 module rack)



EVATEC® Solar 450 mounting rail and accessories

	Product	Prefabricated part/product specification	€/piece
	EVATEC® Solar 450 mounting rail with one Rapid system connector	EVALON® light grey	92.50
		EVALON® slate grey	92.50
		EVALASTIC® light grey	92.50
		EVALASTIC® slate grey	92.50
	alwitra load distribution pad	aluminium	67.50
	Module support profile Pro50	aluminium, length 4750 mm (Packaging unit: 12 pieces/box, 150 pieces/palett)	54.10*
	Module support profile Pro70	aluminium, length 5900 mm (Packaging unit: 8 pieces/carton, 100 pieces/palett)	84.60*
	Module support profile AL10 bottom (expected to be available as of July 2024)	aluminium, length 5900 mm	88.60
	Module support profile AL10 top (expected to be available as of July 2024)	aluminium, length 5900 mm	212.50
	Center clamp RapidPro	aluminium, length 50 mm	1.75
	End clamp RapidPro	aluminium, length 50 mm	1.75
	alwitra mounting base for cable duct	EVALON®/EVALASTIC®	7.30
	EVASTEEL media feed-through set 110 made of stainless steel V4A, DN 100 (OD 110 mm), with EVALON® or EVALASTIC® coated flange made of special V4A stainless coated steel sheet for direct welding of EVALON® or EVALASTIC® connecting flanges (connecting flange included in delivery), incl. stainless steel pipe bend set consisting of 3 x 45° stainless steel pipe bends V2A	EVALON®/EVALASTIC®	249.00
	Roofing screw EJOT JT3-ST-2-6.0	Length 35 mm - 220 mm	Available from EJOT
		Length 240 mm	Price on request
		Length 290 mm	Price on request

All prices are without VAT.

* For quantities deviating from packaging units, an additional packaging charge of 50 € plus VAT will be invoiced.



This version replaces all previous versions. To get the latest version of this document, please scan the QR code or follow this link: alwitra.de/en/downloads

alwitra GmbH
54229 Trier · Germany
Phone: +49 651 9102-0
export@alwitra.de · www.alwitra.de

The information, technical details or installation instructions contained in this document have been compiled to the best of our knowledge and are believed to be correct at the time of publication. alwitra is committed to continuous improvement and therefore reserves the right to change or amend the product specifications without prior notice, particularly, if required to do so by law. No rights may be derived from this document. Changes reserved; typesetting and printing errors excepted.

Version 1. 04/2024